

# Installation of the Windfinder weather station and webcam

## Weather station (Davis Vantage Vue)

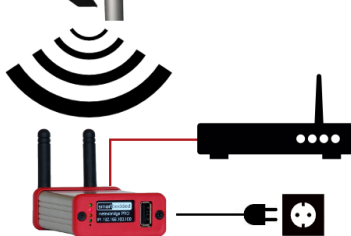

Follow the instructions in the Davis Vantage Vue Integrated Sensor Suite Installation Manual (that came with this package or go to <http://goo.gl/FEITGY>). Ignore the other documents that come with the Vantage Vue.



## Meteobridge Pro+

Plug the network cable into the network (LAN) port of the Meteobridge Pro+ and the other end into a free LAN port of your DSL or UMTS router. Then connect the micro USB end of the power cable into the **left port** on the backside of the

Meteobridge and the other end into a power socket. The Meteobridge will send weather data to Windfinder every 5 minutes.

*If you want to change the configuration of your Meteobridge or have a technical problem (else go to the next chapter): Open a browser on a computer which is connected to the same router / network as the Meteobridge and type the following URL into the address line of your browser (Chrome, Safari, Firefox, Edge, Internet Explorer, etc.): [magicip.meteobridge.com](http://magicip.meteobridge.com). (If that does not work type the IP address from the display on the Meteobridge into your browser, e.g. 192.168.0.2)*

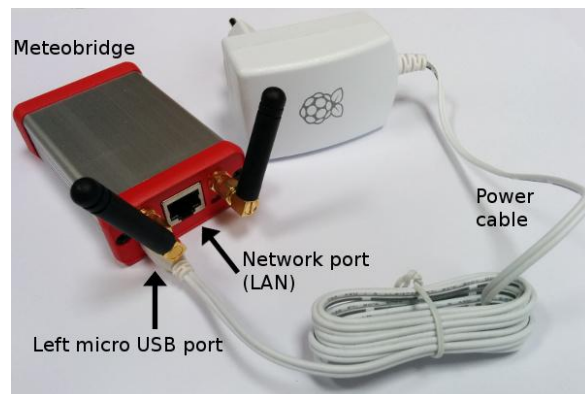

*If everything is set up correctly the login screen of the Meteobridge will appear. If the login screen does not appear wait a few seconds and reload the page. The Meteobridge needs about 60 seconds to boot after being connected to electric power. Log into your Meteobridge:*

*User name: meteobridge*

*Password: meteobridge*

*If a license agreement appears accept it and click "Save and Apply". Go to the tab "Live Data". In the box "Live data" check if there are values in the fields "Rain", "Outdoor" and "Wind". If not press and release the white button on the bottom side of the Vantage vue sensor suite (according to Vantage Vue Integrated Sensor suite installation manual, chapter "Install the*

battery” on page 4) and check again.

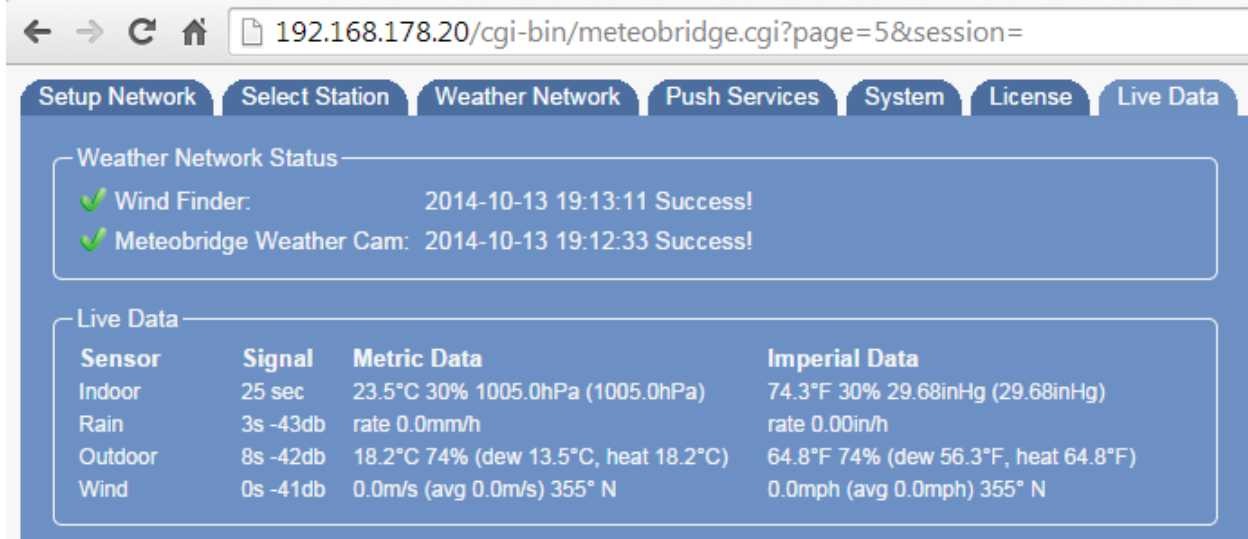

The screenshot shows a web browser interface for the Meteobridge configuration page. The address bar shows the URL: 192.168.178.20/cgi-bin/meteobridge.cgi?page=5&session=.

The interface has several tabs: Setup Network, Select Station, Weather Network, Push Services, System, License, and Live Data. The "Weather Network" tab is active, showing the following status:

- ✓ Wind Finder: 2014-10-13 19:13:11 Success!
- ✓ Meteobridge Weather Cam: 2014-10-13 19:12:33 Success!

The "Live Data" tab is also visible, showing a table of sensor data:

Sensor	Signal	Metric Data	Imperial Data
Indoor	25 sec	23.5°C 30% 1005.0hPa (1005.0hPa)	74.3°F 30% 29.68inHg (29.68inHg)
Rain	3s -43db	rate 0.0mm/h	rate 0.00in/h
Outdoor	8s -42db	18.2°C 74% (dew 13.5°C, heat 18.2°C)	64.8°F 74% (dew 56.3°F, heat 64.8°F)
Wind	0s -41db	0.0m/s (avg 0.0m/s) 355° N	0.0mph (avg 0.0mph) 355° N

## Internet connection via mobile network

If you **don't** have a landline internet connection you can either connect your Meteobridge via network cable to a UMTS/3G router. This works exactly the same way as described above.

Or you plug a USB 3G dongle into the USB on the front side of your Meteobridge. Log into your Meteobridge in the browser at [magicip.meteobridge.com](http://magicip.meteobridge.com) and click on the “network” tab. Click the radio button “3G/GPRS”, select Mode “3G/GPRS”, select provider “Vodafone Germany”, “T-mobile Germany” or “O2 Germany”. If you want to be able to access Meteobridge’s configuration interface then click the check box “act as access point with SSID “MB-XXXXXXXXXXXX” and enter a passphrase and click “Save and apply and reboot”.

## Embed weather data into your website

Please got to <https://www.windfinder.com/apps/homepageweather/>, search for your weather station and configure your weather widgets. Copy & paste the widget code into your website. The code for the reports (live observations from your weather station) will be available only if the weather station is online and sending data to Windfinder.

## Webcam (Standard)

### Configuration

Prior to mounting the webcam at the desired location first create a temporary environment to test the cam. You will need two additional network cables to test the cam. The included PoE adapter will provide power to the cam via the connected network cable. You will not use the external power connector mounted to the cam.

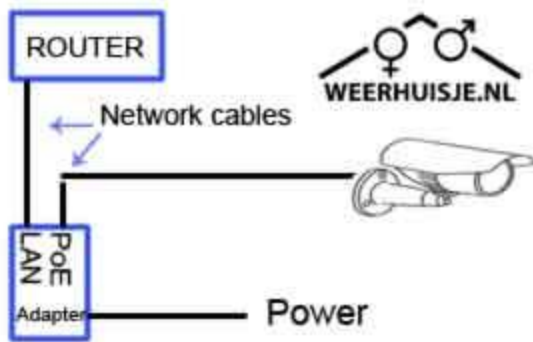

Install the SADP tool from the enclosed CD on your PC or from <https://www.hikvision.com/en/Support/Downloads/Tools>. Launch the SADP tool. It will find your cam's IP address formatted: xxx.xxx.xxx.xxx (i.e 192.168.1.41). Alternatively you can also detect your webcam's IP address with your router.

Login to the Meteobridge at [magicip.meteobridge.com](http://magicip.meteobridge.com). Go to "Station" tab. Scroll down to "Meteobridge Weather Cam", Select "External picture" and enter your webcam's IP address.

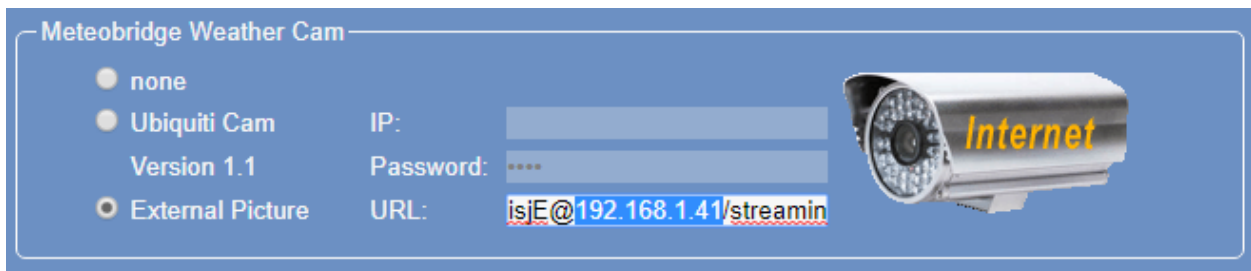

(Webcam URL in this case: admin:W33rhuisjE@192.168.1.41/streaming/channels/102/picture)

Click "Save" on the bottom of this screen. To check if your webcam's IP address was detected correctly click on the webcam symbol on the right hand side. Please note, it can take some time before meteobridge recognizes the webcam.

After you verified the cam showing images in the temporary environment proceed with mounting the cam at the desired position. Consult the package included Quick Start Guide for mounting details.

### Embed Webcam image

In order to embed the webcam image (including live weather data) into your website click on the tab "Weather Nets" of the Meteobridge interface. Click "Add more Weather networks" and select "Meteobridge Weather Camera"

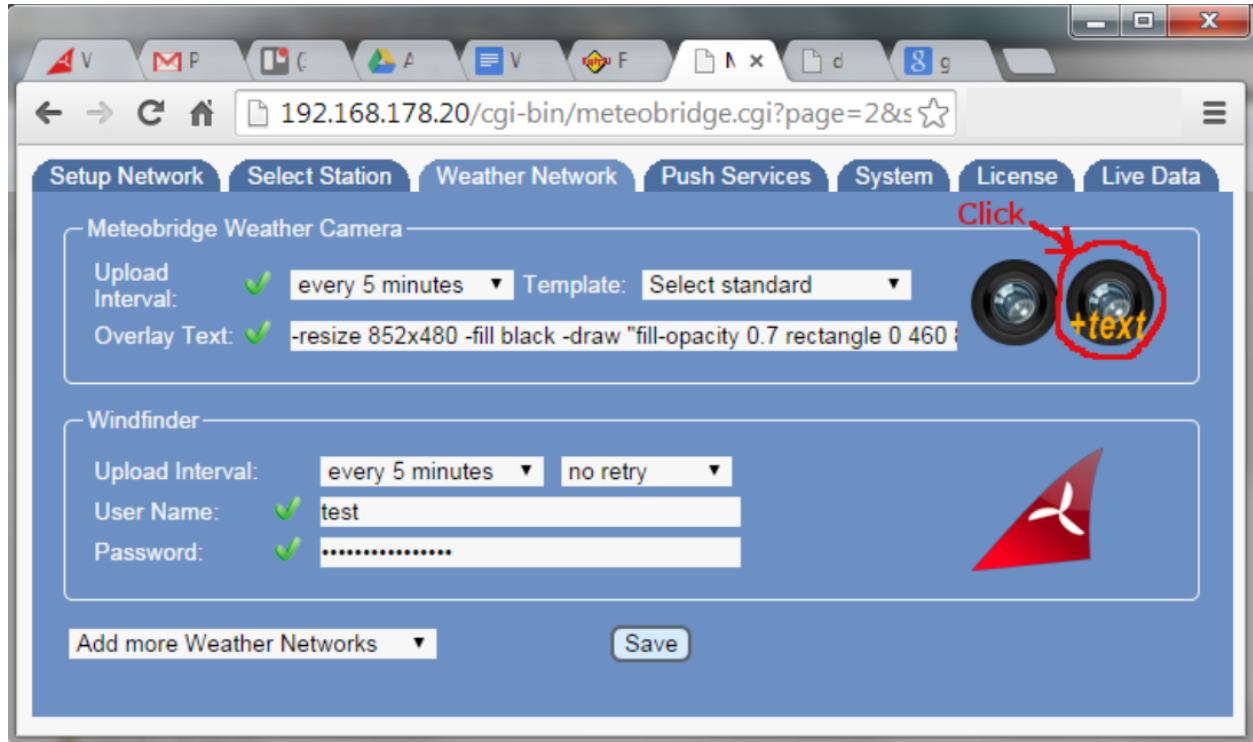

In the box “Meteobridge Weather Camera” select an upload interval, the number of retries, a template and click “Save”.

If you want to embed only the webcam image click on the lense. A new window or tab will open in your browser. If you want to embed the webcam image including the latest weather data (on the webcam snapshot) then click on the lense “+text”. Copy the address string:

..into the following HTML code: ``

Example Result:

```

```

Copy the entire string above into your website where you want to show the webcam image. If you are not familiar with web design or website management ask your web designer.

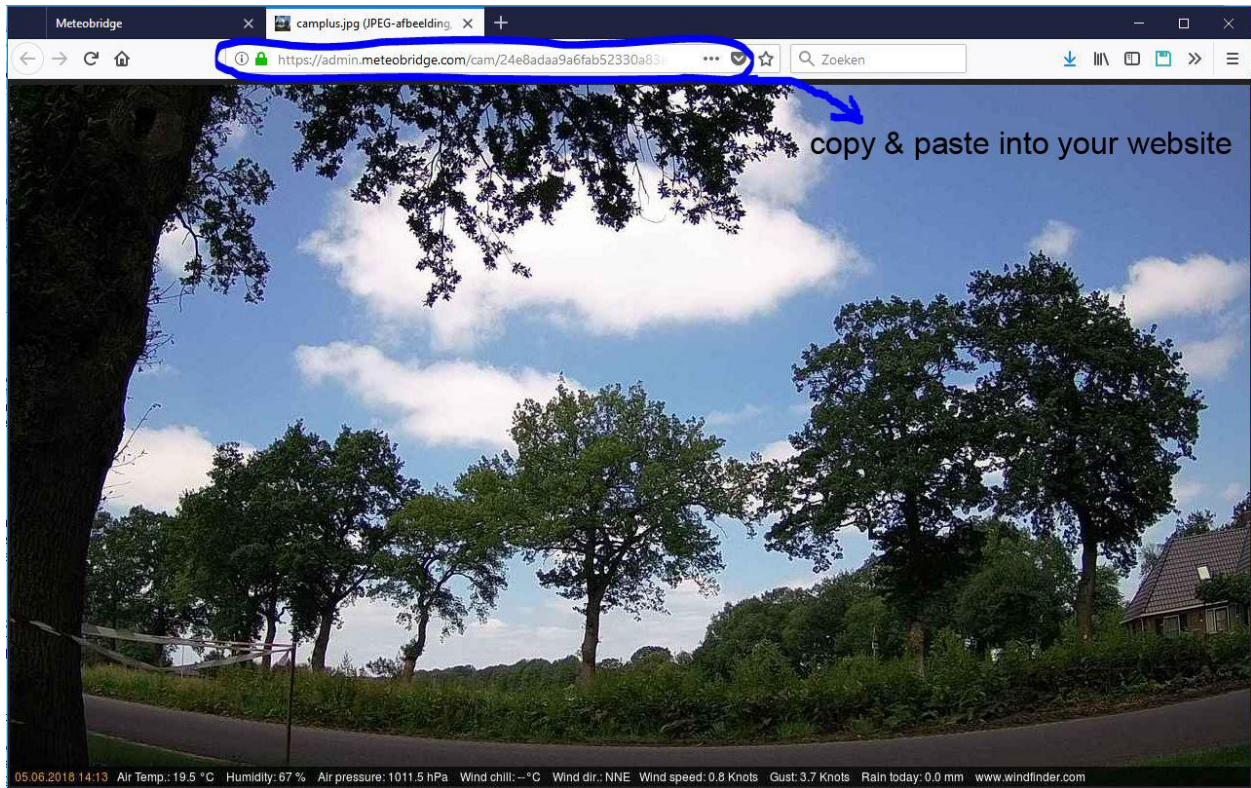

If you want your webcam image to appear on [www.windfinder.com](http://www.windfinder.com) please go to <https://www.webcamgalore.com/submit.html> and submit your webcam with the page URL from the address bar of your browser (see above). It will automatically appear on Windfinder after validation.

## Webcam Streaming

The webcam generates a live video stream. Windfinder does not provide any support for video streaming. However here is a short guide to help you set up your video stream on your website: <http://downloads.windfinder.com/weather-station/webcam-streaming-manual.pdf>